



Product Description: Fuji Printer Head

Applications

The Fuji Printer Head (PHZH1002) is suitable for use with the PHA, PHB and PHC Fuji Microjet Recorders. It is a combination of a head and ink.

Installation instructions

Step 1

Get the recording head ready by taking it out of its aluminium pack.

Step 2

Tear the tape.

Open the cap by turning it in the direction indicated by the arrow.

(If the head is not going to be used for a long time, close the cap back in it's original position.) The cap is integral with the head unit. Turn it about 180° until it stops against the top of the head.

Step 3

Using the provided cloth, lightly press the nozzle surface (the surface from which ink is discharged). Make sure the cloth is properly impregnated with the 4 colours blue, red, red, yellow and black. Press the cloth against the surface for 2 to 3 seconds; if the 4 colours ooze out this shows the nozzles are clear and the printed head is working.

Note: Do not use any other cloth than the supplied one and do not rub the nozzle with the cloth.

How to close the cap:

Turn the cap in the direction indicated by the arrow and press it firmly until it is retained by the stopper. Ink may leak out if the cap is not properly in place.

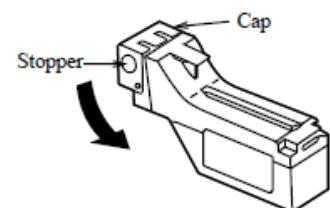
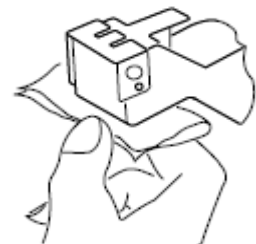
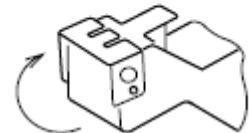
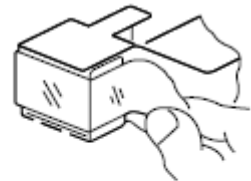
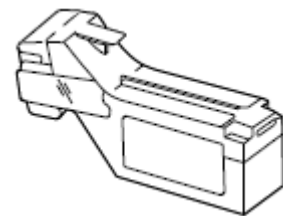



Step 4

Press the RECORD key. Operate the recorder after it has been set in recording stop mode. Open the front door and press down the paper feed unit drawout lever. The paper feed unit will be drawn out.

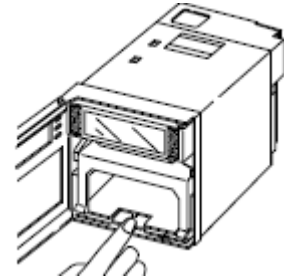

Step 5

Hold the left hand of the indicator and pull it forward. The indicator will turn 90°.

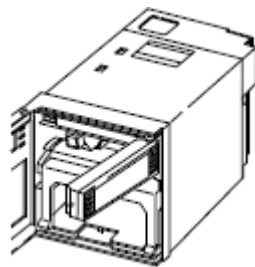

Step 6

Hold the recording head horizontal, line it up with the carriage in the main unit, slide it in slowly and press it firmly until it does not go in any further. Take care not to bang the nozzle surface of the head and avoid touching the nozzle surface with your hand.

CAUTION: Do not touch the connector at the rear of the carriage to avoid the risk of minor electric shocks.

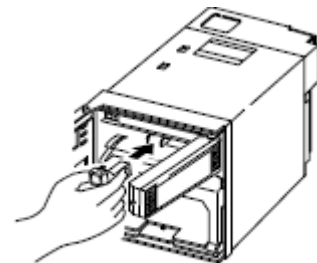

Step 7

Set the indicator in its original position.

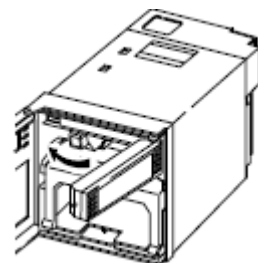



Step 8

Set the paper feed unit in its original position.

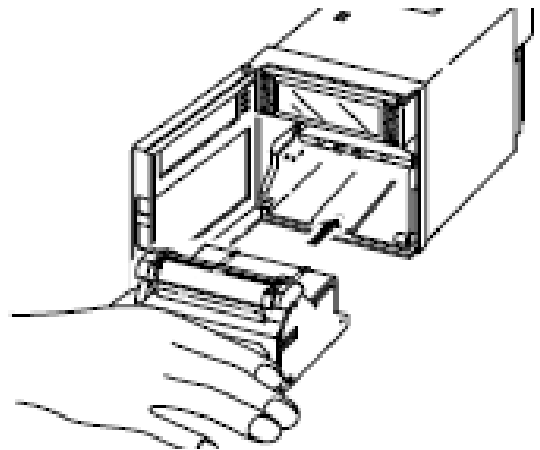

Step 1-8 completes installation of the printer head.

Replacement instructions

Draw out the recording head in the manner that is opposite to what is described in Step 6 of the recording head setting procedure and replace it with a new recording head.

Always carry out the following procedure after replacing a recording head:

1. Setting the ink monitor

Perform the following keying actions in order to get the correct performance of the ink dry-up warning detection function.

- Press the SELECT key to give an "INK MONITOR CLEAR DISPLAY".
- Press the ^ key to change the flickering "NO" to "YES".
- Next, press ENTRY key.
- This completes the setting.
- Press the DISPLAY key to return to a data display.

2. Test pattern print-out

Print out a test pattern to check that normal recording is possible.

3. Adjustment of analog trend recording positions

Readjust the zero and span on the recording paper.

If the ink is not spraying

Hold the recording head with turning the nozzle surface downward and push the side strong until two drops are spilled. Absorb the standing ink on the nozzle surface with the cloth attached. Hold the cloth to the nozzle surface again to find all colours flowed onto cloth. When ink does not come out, repeat the above operations.

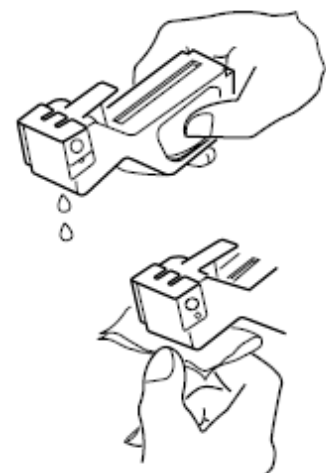



Precautions

If recording is halted and the recorder is not used for a long time

To prevent jamming and drying up of the ink remove the recording head from the main unit, make absolutely sure the cap is closed properly and store the head in a cool, dark place. If the head is left installed in the recorder, do not switch off the power to the recorder and do not close the cap. *Periodically there is an automatic discharge of ink to prevent drying-up, leave the recording paper in place in the recorder. If it is not possible to keep the power switched on, make sure the cap is closed. Draw out the paper feed unit using the recording head installation method Step 4 and Step 5. Open the indicator and tighten the cap.

At the start of use of a recording head

If you are starting to use a new recording head or if the recorder has been left unused for a long time, always wipe the head's nozzle surface lightly with the accessory cloth and check that the 4 colours black, blue, red and yellow ooze out properly into the cloth. When the working environment is 15°C or less, perform a print-out of "test-pattern" after a period of several minutes has elapsed since the recording head was mounted.

Handling recording heads

Do not knock or shake recording heads as this can cause faults. The inks are not harmful but they are very difficult to remove if they adhere to the skin or to clothes, so handle heads carefully in order to avoid staining. Also, do not disassemble them. If, by accident, it happens that ink gets in your eyes, wash thoroughly with water as an emergency measure and then immediately consult a specialist doctor. When the ink is used out, dispose of its recording head as an incombustible object.

Storage of recording heads

When they are delivered, printer heads are in aluminum packs. If you are not going to use a head straight away, leave it sealed and store it in a cool, dark place with an average temperature of 5 to 30°C.

Shipping of recording head

Do not ship the unit recording head after the aluminum pack has been opened. If it is necessary to ship the unit printer head, be sure to close the cap, and ship it as contained in a box in a state where vibration and impact are eased under cushioning materials.